



YMF825

SD-1

universal Sound Designer 1

■ Overview

YMF825 is a sound generator/controller/amplifier device with high quality melodies and keypad/alert tones, designed for sophisticated audio user interface on home appliances and office equipment products.

Yamaha's FM synthesizer produce high fidelity clean vivid sound, in no way comparable to the traditional beeps and chimes used in such products, yet all the control required is just a few tens of bytes of setup parameters.

As many as 16 FM voices are supported, and any host controller can manage those voices using the on-chip melody sequencer that plays tunes autonomously without host controller interventions.

Simple commands allow real time controls of sound during playback, such as changing the volume levels or the repetition intervals of tones.

Moreover, the complete system can be built with the minimum number of external components as the integrated amplifier can directly drive an 8 ohm loudspeaker attached, up to 900 mW.

YAMAHA CORPORATION

YMF825 CATALOG
CATALOG No. LSI-4MF825A40
2011.9

■ Features

- 16-voice polyphonic FM synthesizer
- 29 on-chip operator-waveforms and 8 algorithms offers a whole variety of sound
- Synchronous serial data link for host controller interface
- Integrated loudspeaker driver (Also supports external amplifier connection)
- Integrated 3-band equalizer
- Integrated 16-bit monaural DAC
- Integrated power-on reset
- Flexible Power Supply Configurations

< Single 5-V Power Supply Configuration >

• Speaker driver supply	SPVDD	5.0 ± 0.5V (4.5 V to 5.5 V)
• I/O supply	IOVDD	5.0 ± 0.5V (4.5 V to 5.5 V)
• Core supply	VDD	Supplied from the on-chip regulator

< Dual Power Supply Configuration >

• Speaker driver supply	SPVDD	5.0 ± 0.5V (4.5 V to 5.5 V)
• I/O supply	IOVDD	3.3 ± 0.3V (3.0 V to 3.6 V)
• Core supply	VDD	3.3 ± 0.3V (3.0 V to 3.6 V)

Configuration details

< Single 5-V power supply configuration >

- No need to supply power to the core supply (VDD).
→ Connect only a bypass capacitor to REG_C / VDD pin.
- SPVDD and IOVDD must be connected to the same power supply.

< Dual power supply configuration >

- IOVDD and VDD must be connected to the same power supply.

- Lead-free SSOP24 package (YMF825-EZ)

■ Pin Assignments

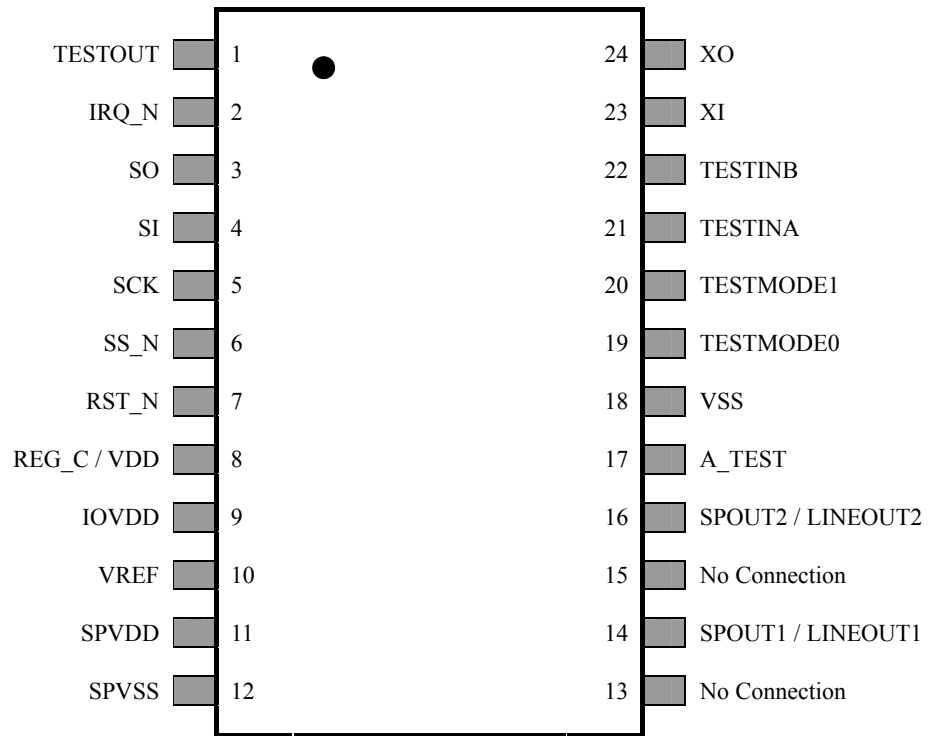

24-pin SSOP TOP View

■ Pin Functions

No.	Name	I/O	Power Supply	Function
1	TESTOUT	O	IOVDD	Test output → This pin should be left open (No Connection).
2	IRQ_N	O	IOVDD	Interrupt output
3	SO	Oe	IOVDD	Serial data output (CPU interface)
4	SI	I	IOVDD	Serial data input (CPU interface)
5	SCK	I	IOVDD	Serial clock (CPU interface)
6	SS_N	I	IOVDD	Chip select (CPU interface)
7	RST_N	Is	IOVDD	Reset → Pull up to IOVDD when not used.
8	REG_C / VDD	AO / P	IOVDD / -	On-chip regulator capacitor connection / Core power supply → < Single 5V power supply configuration > Connect capacitors only. < Dual power supply configuration > Supply 3.3 V (typ.) to VDD from the same power supply as IOVDD.
9	IOVDD	P	-	I/O power supply and on-chip regulator input
10	VREF	AO	VDD	Analog block reference voltage
11	SPVDD	P	-	Speaker amplifier power supply
12	SPVSS	G	-	Speaker amplifier GND
13	(No Connection)	-	-	This pin must be left open. (No Connection) (This pin must be electrically isolated not only from the power supply and ground pins, and adjacent pins, but also from any other pins.)
14	SPOUT1/LINEOUT1	AO	SPVDD	Speaker output 1 / Line output 1
15	(No Connection)	-	-	This pin must be left open. (No Connection) (This pin must be electrically isolated not only from the power supply and ground, pins and adjacent pins, but also from any other pins.)
16	SPOUT2/LINEOUT2	AO	SPVDD	Speaker output 2 / Line output 2
17	A_TEST	AIO	IOVDD	Analog test pin → This pin should be left open (No Connection).
18	VSS	G	-	GND
19	TESTMODE0	I	IOVDD	Test mode configuration → Connect to the VSS.
20	TESTMODE1	I	IOVDD	Test mode configuration → Connect to the VSS.
21	TESTINA	I	IOVDD	Test input pin → Connect to the VSS.
22	TESTINB	I	IOVDD	Test input pin → Connect to the VSS.
23	XI	XI / I	IOVDD	Crystal connection / Clock input → The external clock cannot be used when this device is used in single 5 V power supply configuration. Use a crystal in such designs.
24	XO	XO	IOVDD	Crystal connection → When the external clock is fed to XI pin, this pin must be left open.

AIO : Analog I/O

AO : Analog output

P : Power

G : GND

I : Digital input

Is : Digital input (schmitt)

O : Digital output

Oe : Digital output (3-state)

XI : Crystal resonator input

XO : Crystal resonator output

■ Block Diagram

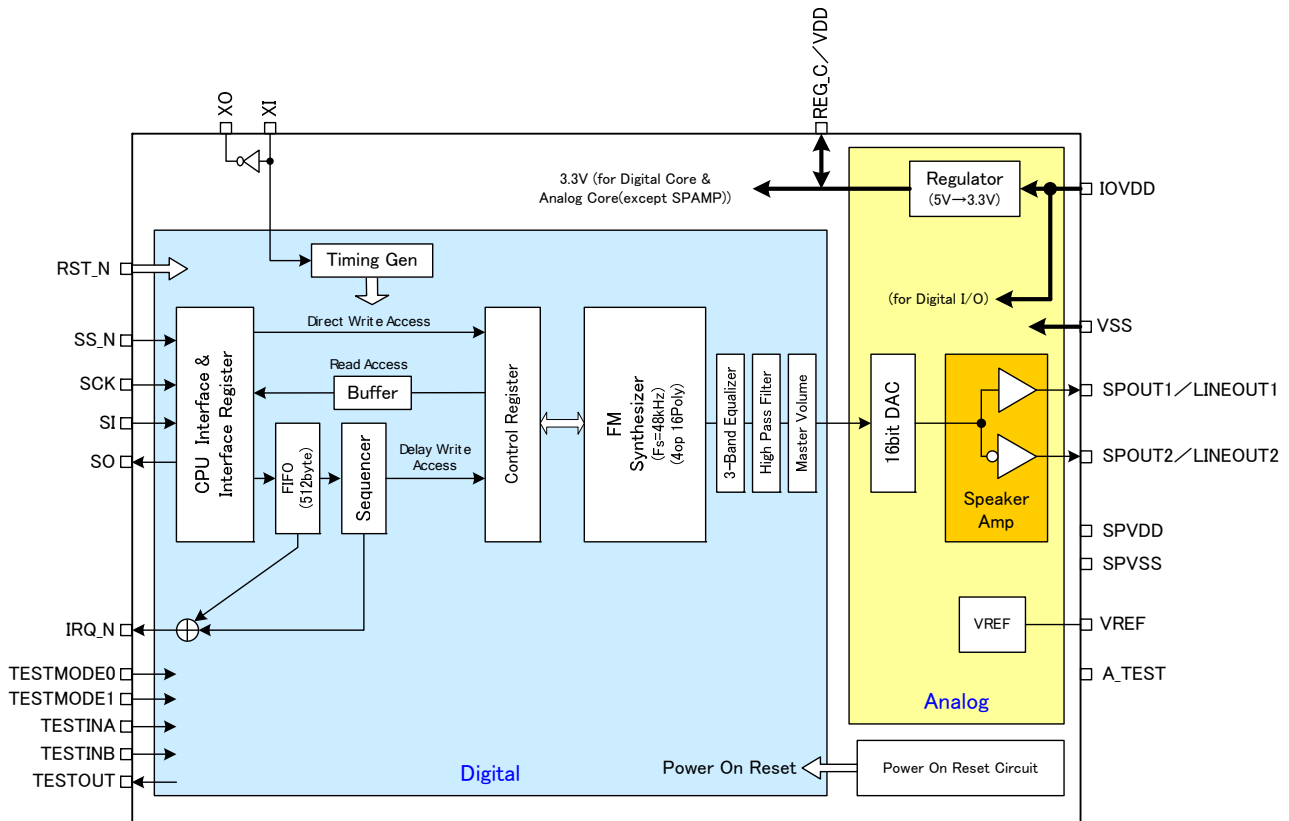

< Timing Gen >

The timing generator block generates clocks and other timing signals required for the operations.

< CPU Interface >

The CPU interface block is a 4-wire CPU serial interface. The use of the interface is based on the assumption that the following four signal lines are connected to host controller CPU: Chip Select (SS_N), Serial Clock (SCK), Data Input (SI), and Data Output (SO).

< Interface Register >

The interface register can be accessed directly from the host controller CPU via the serial interface.

< Control Register >

The control register mainly controls the synthesizer block.

The control register is accessed for the timed-write operations of the sequencer, and also accessed for the direct write or the read operations through the interface register.

< FIFO >

The FIFO, an abbreviation of "First In First Out", is a queue allowing data to be read in the same order they are written. The FIFO is accessed through the interface register and used in the timed-write path to the control register by the sequencer. The size of the FIFO is 512 Bytes.

< Sequencer >

The sequencer controls the de-queuing of the sequenced data queued into the FIFO.

The data structure is as follows:

Timing information (Timer part) + control register address (Address part) + control register data to be written (Data part)

The sequencer waits for the time of the Timer part before writing the Data part to the control register address specified (timed-write operations). This timed de-queuing of the sequenced data to control the FM synthesizer results in the playing back of the music tunes.

< FM Synthesizer >

The polyphonic FM synthesizer can generate up to 16 voices.

Variety in sound authoring is provided with the wider choice of operator waveforms.

The sampling frequency for the internal processing is 48 kHz.

< 3-Band Equalizer >

This is a 3-band digital equalizer.

< High Pass Filter >

This filter, a first-order IIR filter, is the DC-cut high-pass filter.

Its cut-off frequency is 20Hz.

< Master Volume >

This is the digital master control of overall volume level.

< 16-bit DAC >

The DAC block converts the digital signals from the digital block into analog signals.

The data resolution is 16 bits.

< Speaker Amp >

The speaker amplifier is the monaural speaker amplifier with four-level gain settings.

< Regulator >

The linear regulator supplies 3.3V (typ.).

< Power-On Reset >

This circuit resets the registers on power up.

This reset works exactly the same as the hardware reset pin.

 Notes on Power-On Reset

When this device is powered down and then powered up again, this power-on reset may not function unless this device is left unpowered for a sufficient time.

■ Electrical Characteristics

● Absolute Maximum Ratings

Parameter	Symbol	Min.	Max.	Unit
SPVDD supply voltage	SPVDD	-0.3	7.0	V
IOVDD supply voltage	IOVDD	-0.3	7.0	V
VDD supply voltage	VDD	-0.3	4.6	V
Digital input voltage (See Note 1.)	V _{IND}	-0.3	IOVDD+0.3	V
Analog input voltage	V _{INA}	-0.3	IOVDD+0.3	V
Power dissipation (See Note 2.)	Pd		1638	mW
Junction Temperature	T _j		150	°C
Storage Temperature	T _{STG}	-50	150	°C

Conditions VSS=SPVSS=0 V

Note1) These limits must be observed even if the supply voltage is out of the recommended operating voltage range.

For example, when the power supply pin is at 0 V, any voltage over 0.3V is beyond the limit.

Note 2) Conditions:

- Top= 25 °C, PCB (50 mm × 50 mm × 1.6 mm), FR-2 board, trace density 50 %
- Derate the value with 13.1 mW/°C for the temperature above 25 °C.

● **Recommended Operating Conditions**

• **Single 5-V Power Supply Configuration**

Parameter	Symbol	Min.	Typ.	Max.	Unit
SPVDD supply voltage	SPVDD	4.5	5.0	5.5	V
IOVDD supply voltage	IOVDD	4.5	5.0	5.5	V
Speaker load resistance	R_L	6.4	8.0		Ω
Operating ambient temperature	T_a	-20	25	85	$^{\circ}\text{C}$

Conditions VSS=SPVSS=0 V

Notes

- IOVDD and SPVDD must be connected to the same power supply.
- Connect only a capacitor to REG_C / VDD pin and do not supply powers.

• **Dual Power Supply Configuration**

Parameter	Symbol	Min.	Typ.	Max.	Unit
SPVDD supply voltage	SPVDD	4.5	5.0	5.5	V
IOVDD supply voltage	IOVDD	3.0	3.3	3.6	V
VDD supply voltage	VDD	3.0	3.3	3.6	V
Speaker load resistance	R_L	6.4	8.0		Ω
Operating ambient temperature	T_a	-20	25	85	$^{\circ}\text{C}$

Conditions VSS=SPVSS=0 V

Note

- IOVDD and VDD must be connected to the same power supply.

● **Power Consumption**

All the drawn current values in the tables are typical representative values to help your design decisions.

▪ **Single 5-V Power Supply Configuration**

Parameter	Conditions	IOVDD	SPVDD	Unit
Drawn current, normal operation (AP*=all "0", CLKE="1")	No signal output	17	5	mA
	R _L =8Ω load, f=1kHz, 400mW		200	mA
Drawn current, power-down (AP0="0", AP[1/2/3]="1", CLKE="0")	V _{IL} =VSS, V _{IH} =IOVDD	5	0	mA

Conditions SPVDD = IOVDD = 5.0 V, room temperature.

▪ **Dual Power Supply Configuration**

i) **Use of Crystal Resonator**

Parameter	Conditions	IOVDD (+ VDD)	SPVDD	Unit
Drawn current, normal operation (AP*=all "0", CLKE="1")	No signal output	15	5	mA
	R _L =8Ω load, f=1kHz, 400mW		200	mA
Drawn current, power-down (AP0="0", AP[1/2/3]="1", CLKE="0")	V _{IL} =VSS, V _{IH} =IOVDD	3	0	mA

Conditions SPVDD = 5.0 V, IOVDD = VDD = 3.3 V, room temperature.

ii) **Use of External Clock**

Parameter	Conditions	IOVDD (+ VDD)	SPVDD	Unit
Drawn current, normal operation (AP*=all "0", CLKE="1")	No signal output	14	5	mA
	R _L =8Ω load, f=1kHz, 400mW		200	mA
Drawn current, power-down (AP0="0", AP[1/2/3]="1", CLKE="0")	V _{IL} =VSS, V _{IH} =IOVDD	2	0	mA

Conditions SPVDD = 5.0 V, IOVDD = VDD = 3.3 V, room temperature.

XI pin: 12.288 MHz clock, XO pin: No connection

● DC Characteristics

Parameter	Symbol	Condition	Min.	Typ.	Max.	Unit
Input Voltage “H” level (1)	V _{IH}	(See Note 1.)	0.80 × IOVDD			V
Input Voltage “L” level (1)	V _{IL}	(See Note 1.)			0.20 × IOVDD	V
Input Voltage “H” level (2)	V _{IH}	(See Note 2.)	0.70 × IOVDD			V
Input Voltage “L” level (2)	V _{IL}	(See Note 2.)			0.30 × IOVDD	V
Output Voltage “H” level (1)	V _{OH}	I _{OH} = (See Note 3.)	0.80 × IOVDD			V
Output Voltage “L” level (1)	V _{OL}	I _{OL} = (See Note 3.)			0.20 × IOVDD	V
Schmitt hysteresis width	V _{sh}	(See Note 4.)		0.20 × IOVDD		mV
Input leakage current	IL		-10		10	μA
Input capacitance	CI				10	pF

Conditions Capacitor load=30pF. For operations under the recommended operating conditions

Note 1: RST_N pin only

Note 2: SI, SCK, SS_N, and XI (only when an external clock is used) pins only

Note 3: IRQ_N: 2mA

SO: 4mA

Note 4: RST_N only

 **Note**

Consider the use of signal damping resistors where appropriate, in product designs.

● AC Characteristics

Power Supply Timing Requirements

Either requirements A or B must be met:

● Requirement A

Parameter	Symbol	Min.	Typ.	Max.	Unit
Supply voltage rise time (See Note 1.)	T_{VRISE}			10	ms
Power off interval (See Note 2.)	T_{VOFF}	100			ms

Conditions For operations under the recommended operating conditions

● Requirement B

Parameter	Symbol	Min.	Typ.	Max.	Unit
Supply voltage rise time (See Note 1.)	T_{VRISE}			10	ms
Reset N "L" pulse width	T_{RSTW}	1			ms
Reset N (undefined → "L") Setup Time	T_{RSTS}	0			μs

Conditions For operations under the recommended operating conditions

Note 1) This specifies the supply voltage rise time requirement (from power up until the minimum supply voltage value of the recommended operating conditions is reached).

Note 2) This specifies the unpowered interval required before the device can power up again.
 If this requirement is not met, the power-on reset may not be performed properly.
 Be sure to meet this requirement for the system without using RST_N pin.

< Single 5-V Power Supply Configuration >

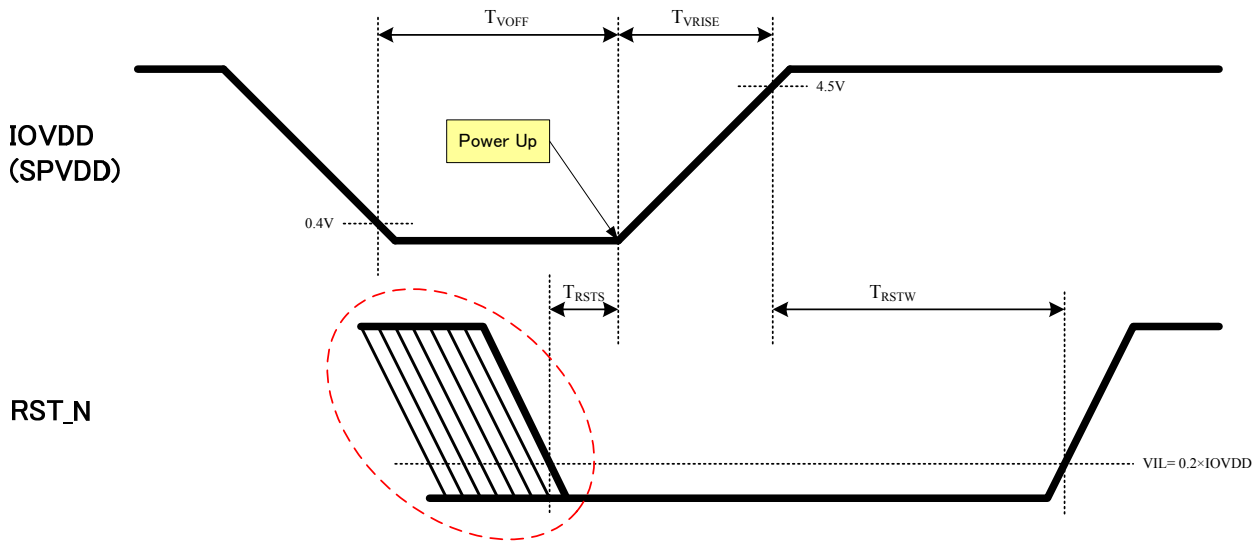

↑ Keep RST_N signal within the maximum absolute ratings including these undefined periods.

< Dual Power Supply Configuration >

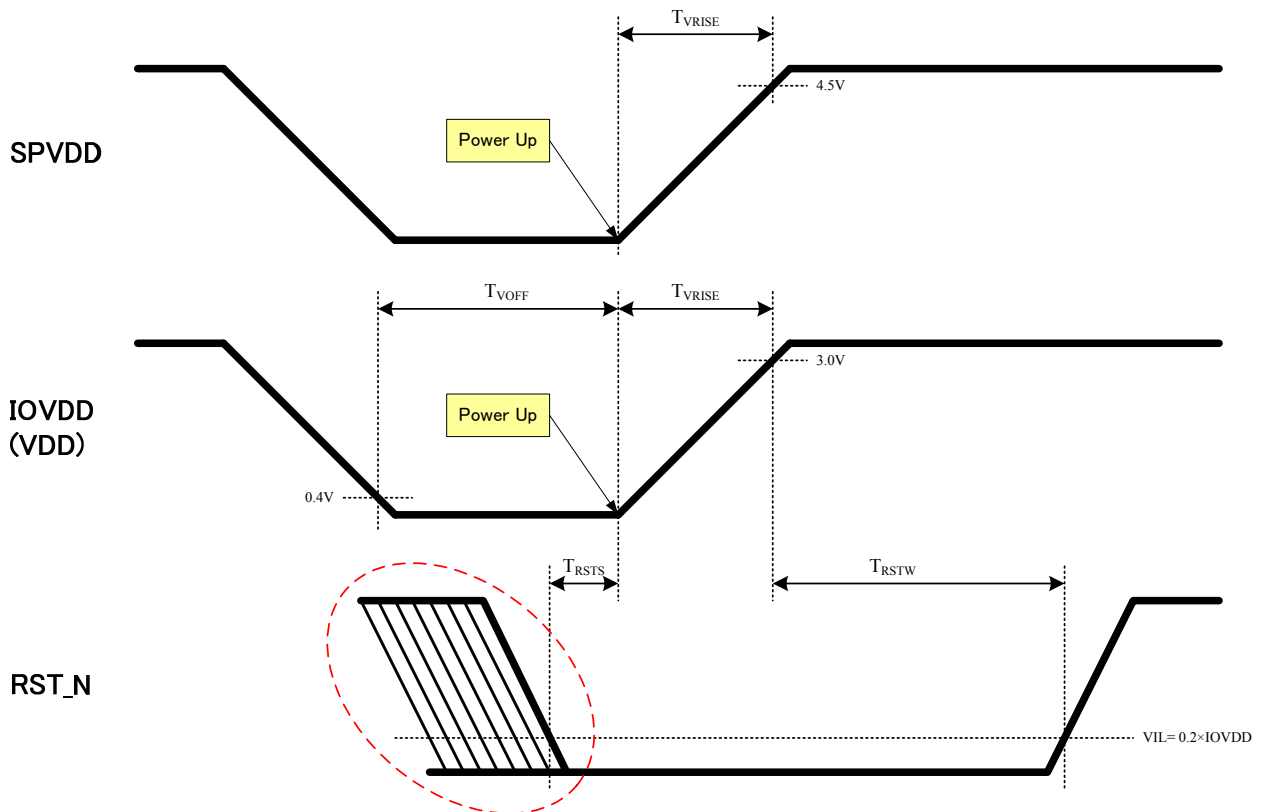

↑ Keep RST_N signal within the maximum absolute ratings including these undefined periods.

Notes

< Single 5-V Power Supply Configuration >

- IOVDD and SPVDD must be connected to the same power supply.

< Dual Power Supply Configuration >

- IOVDD and VDD must be connected to the same power supply.

Input Clock (XI) Requirements

Parameter	Symbol	Min.	Typ.	Max.	Unit
XI frequency	$1 / T_{freq}$		12.288		MHz
XI Rise time, Fall time (See Note 1.)	T_{rckc}, T_{fckc}			20	ns
XI High time (See Note 1.)	T_h	20			ns
XI Low time (See Note 1.)	T_l	20			ns
Frequency tolerance	—	-100		+100	ppm

Conditions For operations under the recommended operating conditions

Note 1) These values specify the requirements for the external clocks on XI pin.

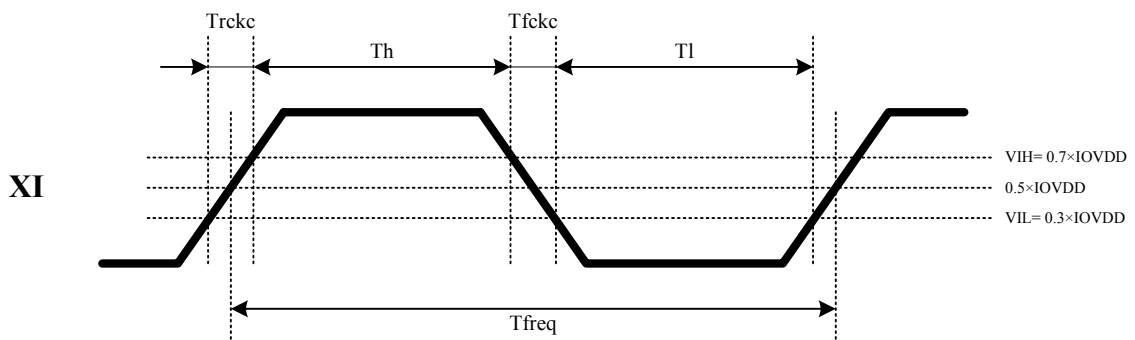

CPU Interface

Parameter	Symbol	Min.	Typ.	Max.	Unit
SCK Period	Tsck_period	100			ns
SCK "L" pulse width (See Note 1.)	Tsck_low	45			ns
SCK "H" pulse width (See Note 1.)	Tsck_high	45			ns
SCK Rise time	Tsck_rise			5	ns
SCK Fall time	Tsck_fall			5	ns
SS_N "H" pulse width (See Note 2.)	Tssn_high	500 / 100			ns
SS_N Rise time	Tssn_rize			5	ns
SS_N Fall time	Tssn_fall			5	ns
SS_N Setup time	Tssn_setup	15			ns
SS_N Hold time	Tssn_hold	10			ns
SI Rise time	Tsi_rize			5	ns
SI Fall time	Tsi_fall			5	ns
SI Setup time	Tsi_setup	15			ns
SI Hold ime	Tsi_hold	10			ns
SO Output Delay 1	Tso_delay1			30	ns
SO Output Delay 2	Tso_delay2			30	ns
SO Output Delay 3	Tso_delay3			30	ns

Conditions Capacitor Load=30pF. For operations under the recommended operating conditions

$I_{OH} / I_{OL} = 0$ mA (SO pin only)

Input signal levels: $V_{IH} = IOVDD$, $V_{IL} = 0$ V

Logic threshold levels: $V_{IH} = 0.70 \times IOVDD$, $V_{IL} = 0.30 \times IOVDD$

$V_{OH} = 0.70 \times IOVDD$, $V_{OL} = 0.30 \times IOVDD$

Note 1) The sum of the two periods Tsck_low + Tsck_high must be equal to the minimum value of Tsck_period or greater.

Note 2) When I_ADR#21 and #22 are used to read a control register, a write to I_ADR#21 must be followed by SS_N kept "H" for 500 ns before I_ADR#22 is ready for a read.

For other use, SS_N must be "H" for 100 ns between accesses.

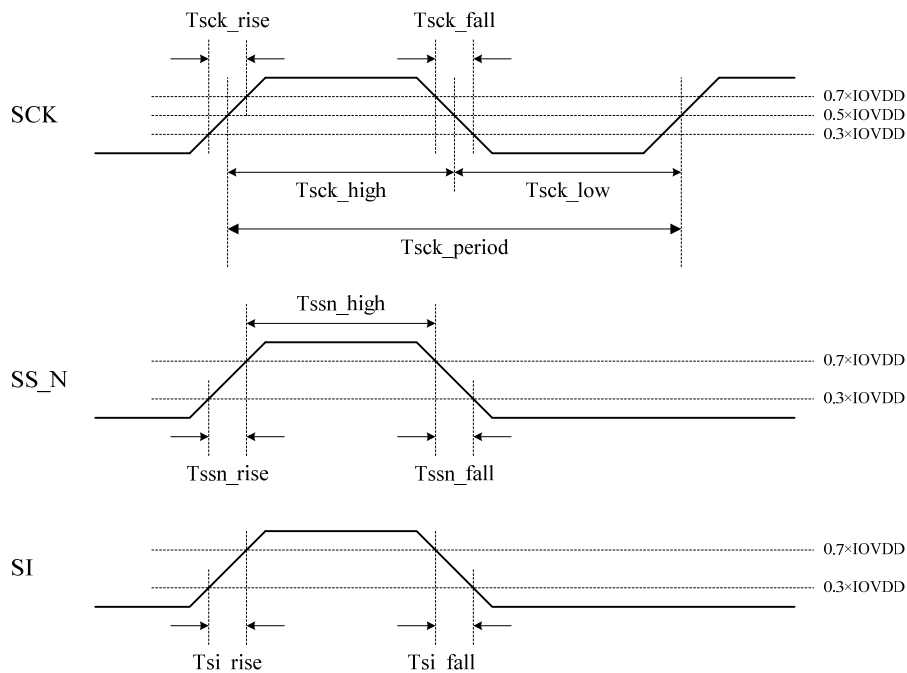

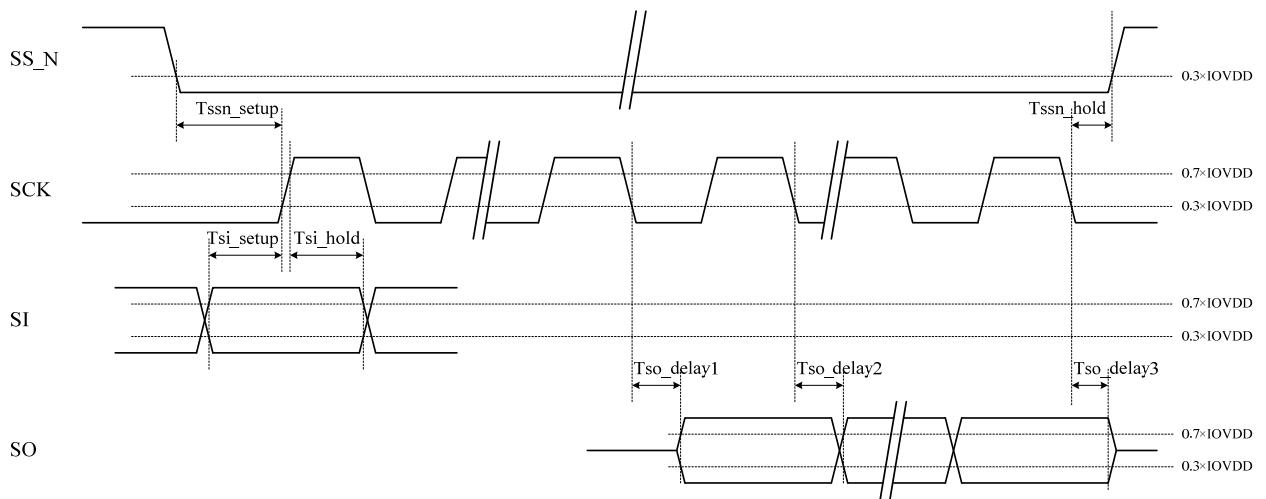

● Analog Characteristics

The measurement conditions are as follows:

T_{OP}=25 °C

IOVDD=SPVDD=5 V

GAIN[1:0]= "1"(6.5 dB), RL=8Ω, C_{REG_OUT}=4.7μF, C_{VREF}=1μF

Parameter	Min.	Typ.	Max.	Unit
Maximum Output Power GAIN[1:0]= "2'b11"(7.5dB)		900		mW
Maximum Output Voltage Amplitude GAIN[1:0]= "2'b11"(7.5dB)		7.58		Vp-p
Output Offset Voltage		10	50	mV
Quiescent Output Voltage		2.50		V
Frequency Characteristics (50Hz to 20kHz, with reference to the 1kHz level)	-3.5		0.5	dB
Total Harmonic Distortion (1kHz, 400mW, 22kHz LPF)		0.3		%
Residual Noise Level (A-weighted)		-85		dBV
Capacitive Load on Speaker Output			1000	pF
VREF Voltage		1.65		V
VREF Settling Time			30	ms
On-chip Regulator Output Voltage		3.3		V
On-chip Regulator Settling Time		27	100	μs

■ Package Information

U-PK24EP2-01-1

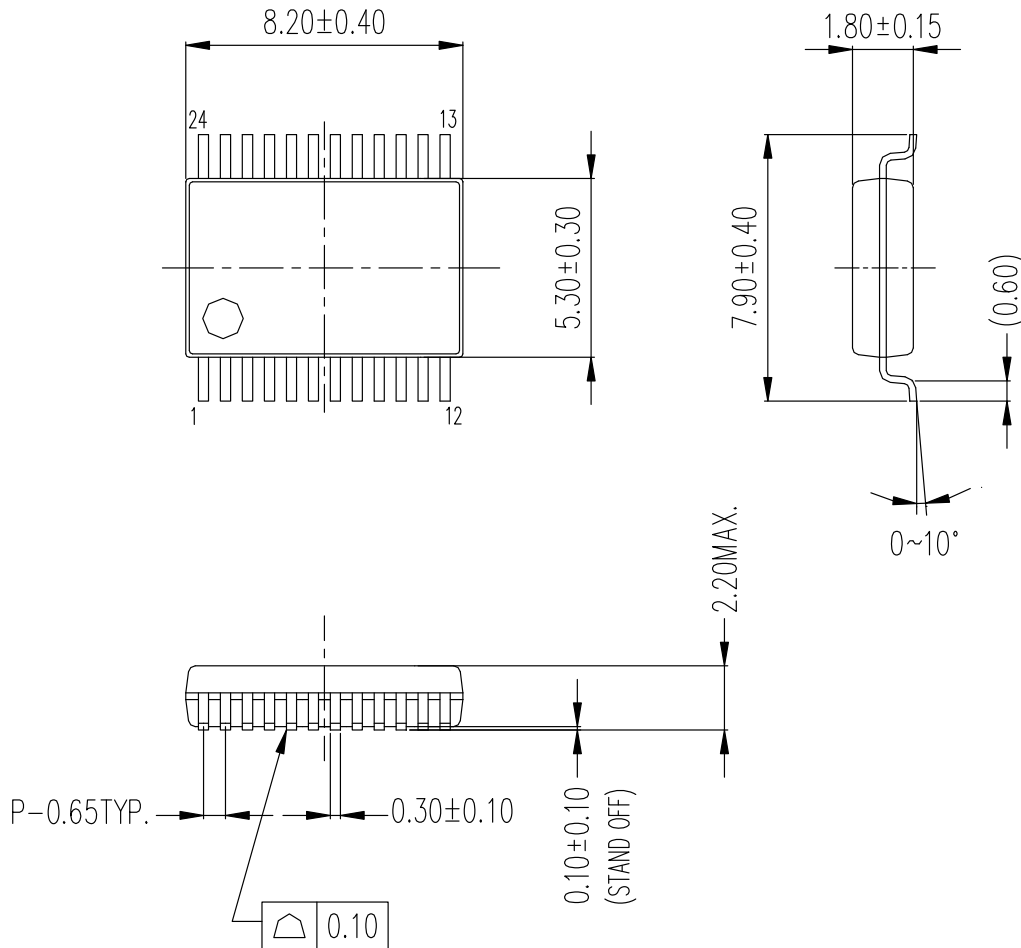

端子厚さ : 0.22 ± 0.10
(LEAD THICKNESS)

カッコ内の寸法値は参考値とします。
The value parenthesized is not specified.





モールド外形寸法はバリを含みません。
Plastic body dimensions do not include burr of resin.









UNIT : mm

- 注) 1. 表面実装LSIは、保管条件、および、半田付けについての特別な配慮が必要です。
2. 組立工場により、寸法や形状などが異なる場合があります。
詳しくはヤマハ代理店までお問い合わせください。

- Note: 1. Special attention needs to be paid to the storage conditions and soldering method of the surface mount IC.
2. Dimension, form, etc. may differ depending on assembly plants.
For details, please contact your local Yamaha agent.

PRECAUTIONS AND INSTRUCTIONS FOR SAFETY

 WARNING	
 Prohibited	<p>Do not use the device under stresses beyond those listed in Absolute Maximum Ratings. Such stresses may become causes of breakdown, damages, or deterioration, causing explosion or ignition, and this may lead to fire or personal injury.</p>
 Prohibited	<p>Do not mount the device reversely or improperly and also do not connect a supply voltage in wrong polarity. Otherwise, this may cause current and/or power-consumption to exceed the absolute maximum ratings, causing personal injury due to explosion or ignition as well as causing breakdown, damages, or deterioration.</p> <p>And, do not use the device again that has been improperly mounted and powered once.</p>
 Prohibited	<p>Do not short between pins.</p> <p>In particular, when different power supply pins, such as between high-voltage and low-voltage pins, are shorted, smoke, fire, or explosion may take place.</p>
 Instructions	<p>As to devices capable of generating sound from its speaker outputs, please design with safety of your products and system in mind, such as the consequences of unusual speaker output due to a malfunction or failure. A speaker dissipates heat in a voice-coil by air flow accompanying vibration of a diaphragm. When a DC signal (several Hz or less) is input due to device failure, heat dissipation characteristics degrade rapidly, thereby leading to voice-coil burnout, smoking or ignition of the speaker even if it is used within the rated input value.</p>

 CAUTION	
 Prohibited	<p>Do not use Yamaha products in close proximity to burning materials, combustible substances, or inflammable materials, in order to prevent the spread of the fire caused by Yamaha products, and to prevent the smoke or fire of Yamaha products due to peripheral components.</p>
 Instructions	<p>Generally, semiconductor products may malfunction and break down due to aging, degradation, etc. It is the responsibility of the designer to take actions such as safety design of products and the entire system and also fail-safe design according to applications, so as not to cause property damage and/or bodily injury due to malfunction and/or failure of semiconductor products.</p>
 Instructions	<p>The built-in DSP may output the maximum amplitude waveform suddenly due to malfunction from disturbances etc. and this may cause damage to headphones, external amplifiers, and human body (the ear). Please pay attention to safety measures for device malfunction and failure both in product and system design.</p>
 Instructions	<p>As semiconductor devices are not nonflammable, overcurrent or failure may cause smoke or fire. Therefore, products should be designed with safety in mind such as using overcurrent protection circuits to control the amount of current during operation and to shut off on failure.</p>
 Instructions	<p>Products should be designed with fail safe in mind in case of malfunction of the built-in protection circuits. Note that the built-in protection circuits such as overcurrent protection circuit and high-temperature protection circuit do not always protect the internal circuits. In some cases, depending on usage or situations, such protection circuit may not work properly or the device itself may break down before the protection circuit kicks in.</p>
 Instructions	<p>Use a robust power supply.</p> <p>The use of an unrobust power supply may lead to malfunctions of the protection circuit, causing device breakdown, personal injury due to explosion, or smoke or fire.</p>
 Instructions	<p>Product's housing should be designed with the considerations of short-circuiting between pins of the mounted device due to foreign conductive substances (such as metal pins etc.). Moreover, the housing should be designed with spatter prevention etc. due to explosion or burning. Otherwise, the spattered substance may cause bodily injury.</p>
 Instructions	<p>The device may be heated to a high temperature due to internal heat generation during operation. Therefore, please take care not to touch an operating device directly.</p>

v02

IMPORTANT NOTICE

1. YAMAHA RESERVES THE RIGHT TO MAKE CHANGES TO ITS PRODUCTS AND TO THIS DOCUMENT WITHOUT NOTICE. THE INFORMATION CONTAINED IN THIS DOCUMENT HAS BEEN CAREFULLY CHECKED AND IS BELIEVED. HOWEVER, YAMAHA SHALL ASSUME NO RESPONSIBILITIES FOR INACCURACIES AND MAKE NO COMMITMENT TO UPDATE OR TO KEEP CURRENT THE INFORMATION CONTAINED IN THIS DOCUMENT.
2. THESE YAMAHA PRODUCTS ARE DESIGNED ONLY FOR COMMERCIAL AND NORMAL INDUSTRIAL APPLICATIONS, AND ARE NOT SUITABLE FOR OTHER USES, SUCH AS MEDICAL LIFE SUPPORT EQUIPMENT, NUCLEAR FACILITIES, CRITICAL CARE EQUIPMENT OR ANY OTHER APPLICATION THE FAILURE OF WHICH COULD LEAD TO DEATH, PERSONAL INJURY OR ENVIRONMENTAL OR PROPERTY DAMAGE. USE OF THE PRODUCTS IN ANY SUCH APPLICATION IS AT THE CUSTOMER'S OWN RISK AND EXPENSE.
3. YAMAHA SHALL ASSUME NO LIABILITY FOR INCIDENTAL, CONSEQUENTIAL OR SPECIAL DAMAGES OR INJURY THAT MAY RESULT FROM MISAPPLICATION OR IMPROPER USE OR OPERATION OF THE PRODUCT.
4. YAMAHA MAKES NO WARRANTY OR REPRESENTATION THAT THE PRODUCTS ARE SUBJECT TO INTELLECTUAL PROPERTY LICENSE FROM YAMAHA OR ANY THIRD PARTY, AND YAMAHA MAKES NO WARRANTY OR REPRESENTATION OF NON-INFRINGEMENT WITH RESPECT TO THE PRODUCTS. YAMAHA SPECIFICALLY EXCLUDES ANY LIABILITY TO THE CUSTOMER OR ANY THIRD PARTY ARISING FROM OR RELATED TO THE PRODUCTS INFRINGEMENT OF ANY THIRD PARTY'S INTELLECTUAL PROPERTY RIGHTS, INCLUDING THE PATENT, COPYRIGHT, TRADEMARK OR TRADE SECRET RIGHTS OF ANY THIRD PARTY.
5. EXAMPLES OF USE DESCRIBED HEREIN ARE MERELY TO INDICATE THE CHARACTERISTICS AND PERFORMANCE OF PRODUCTS. YAMAHA SHALL ASSUME NO RESPONSIBILITY FOR ANY INTELLECTUAL PROPERTY CLAIMS OR OTHER PROBLEMS THAT MAY RESULT FROM APPLICATIONS BASED ON THE EXAMPLES DESCRIBED HEREIN. YAMAHA MAKES NO WARRANTY WITH RESPECT TO THE PRODUCTS, EXPRESS OR IMPLIED, INCLUDING, BUT NOT LIMITED TO THE WARRANTIES OF MERCHANTABILITY, FITNESS FOR A PARTICULAR USE AND TITLE.
6. YAMAHA MAKES EVERY EFFORT TO IMPROVE THE QUALITY AND RELIABILITY OF ITS PRODUCTS. HOWEVER, ALL SEMICONDUCTOR PRODUCTS FAIL WITH SOME PROBABILITY. THEREFORE, YAMAHA REQUIRES THAT SUFFICIENT CARE BE GIVEN TO ENSURING SAFE DESIGN IN CUSTOMER PRODUCTS SUCH AS REDUNDANT DESIGN, ANTI-CONFLAGRATION DESIGN, AND DESIGN FOR PREVENTING MALFUNCTION IN ORDER TO PREVENT ACCIDENTS RESULTING IN INJURY OR DEATH, FIRE OR OTHER SOCIAL DAMAGE FROM OCCURRING AS A RESULT OF PRODUCT FAILURE.
7. INFORMATION DESCRIBED IN THIS DOCUMENT: APPLICATION CIRCUITS AND ITS CONSTANTS AND CALCULATION FORMULAS, PROGRAMS AND CONTROL PROCEDURES ARE PROVIDED FOR THE PURPOSE OF EXPLAINING TYPICAL OPERATION AND USAGE. THEREFORE, PLEASE EVALUATE THE DESIGN SUFFICIENTLY AS WHOLE SYSTEM UNDER THE CONSIDERATION OF VARIOUS EXTERNAL OR ENVIRONMENTAL CONDITIONS AND DETERMINE THEIR APPLICATION AT THE CUSTOMER'S OWN RISK. YAMAHA SHALL ASSUME NO RESPONSIBILITY FOR CLAIMS, DAMAGES, COSTS AND EXPENSES CAUSED BY THE CUSTOMER OR ANY THIRD PARTY, OWING TO THE USE OF THE ABOVE INFORMATION.

Notice The specifications of this product are subject to improvement changes without prior notice

AGENT

YAMAHA CORPORATION

Address Inquiries to :

Semiconductor Sales & Marketing Department

- **Head Office** 203, Matsunokijima, Iwata,
Shizuoka, 438-0192, Japan
Tel. +81-539-62-4918 Fax. +81-539-62-5054
- **Tokyo Office** 2-17-11, Takanawa, Minato-ku,
Tokyo, 108-8586, Japan
Tel. +81-3-5488-5431 Fax. +81-3-5488-5088
- **Osaka Office** Universal City Wako Bldg.
6-2-82, Shimaya, Konohana-ku,
Osaka, 554-0024, Japan
Tel. +81-6-6465-0325 Fax. +81-6-6465-0391